

# Dulap pentru încălțăminte

## Modul N°7

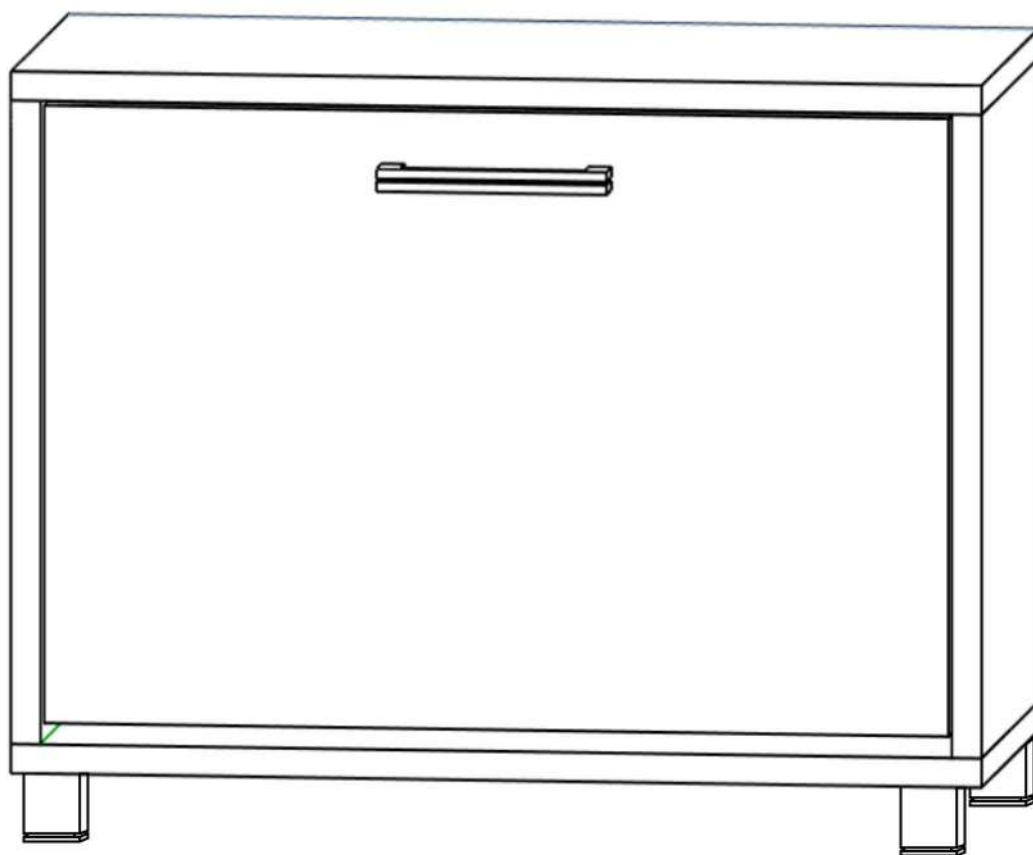

**Adrese:**  
Prospectul Republicii, 33  
Cahul, Moldova

str. Petricani 17/4  
Chisinau, Moldova

MD-3909

[serviceclient@fabrikhome.md](mailto:serviceclient@fabrikhome.md)  
[www.fabrikhome.md](http://www.fabrikhome.md)

**Serviciu clienti:**  
+373 299 32 277  
+373 799 07 807

**Control calitate:**  
+373 798 82 000



**Fabrik Home**

Mobila. Decor. Opinia.  
S.C."Interstepcom" S.R.L.

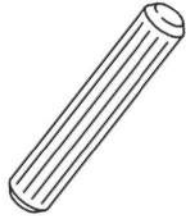
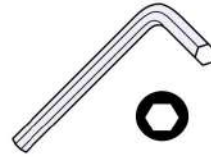
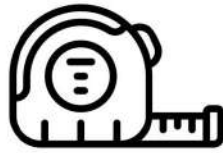
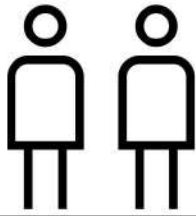

A x10



B x10



C x10

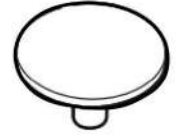

D x10

3.5\*16mm



E x48



F x1



G x15gr.

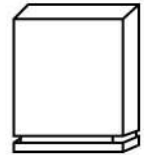

H x4

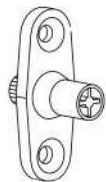

J x2



K x2

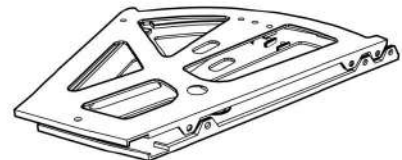

L x1



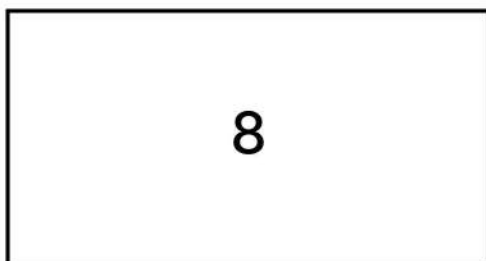
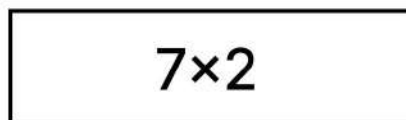
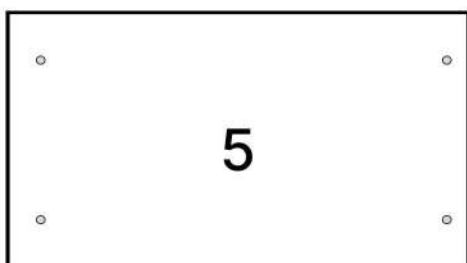
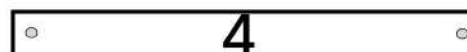
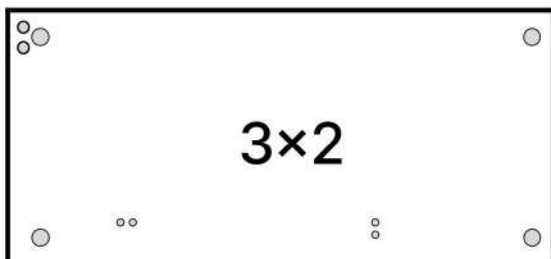
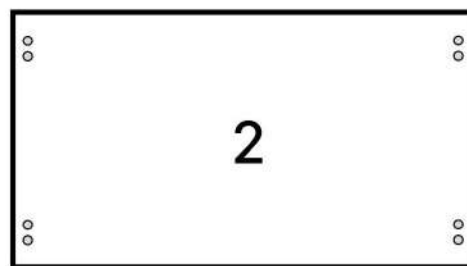
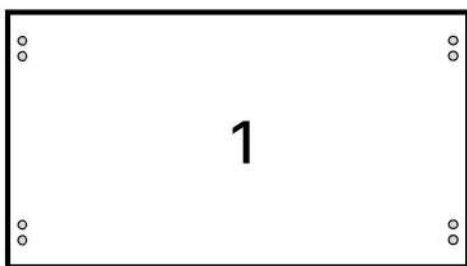

No	Denumire	Dimensiuni	Buc
1	Placă superioară	600x288	1
2	Placă inferioară	600x285	1
3	Perete laterală	398x285	2
4	Placă corp	563x100	1
5	Ușa	382x559	1
6	Placa	530x108	1
7	Placa	530x150	2
8	Spate corp (PFL)	598x416	1

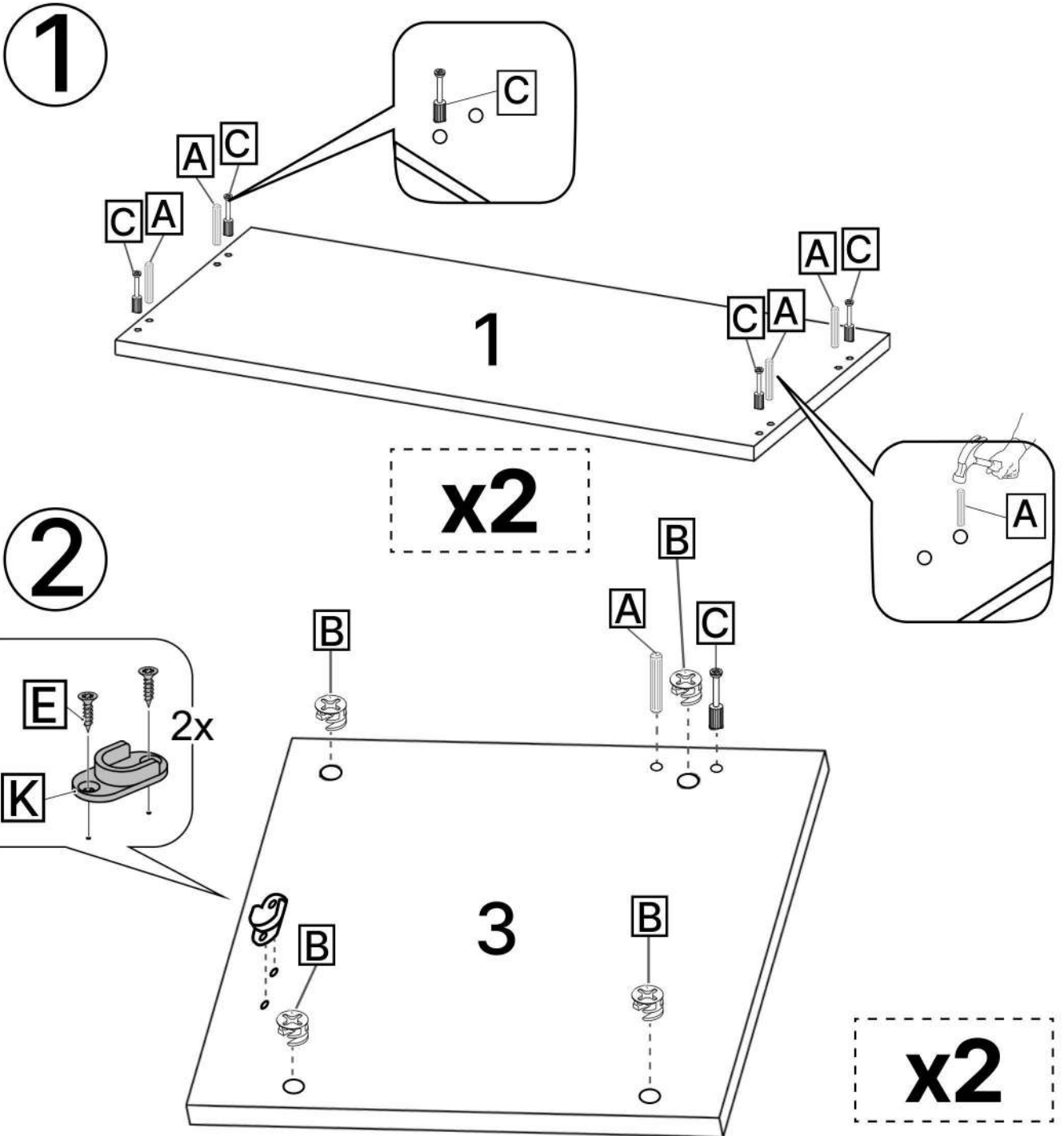
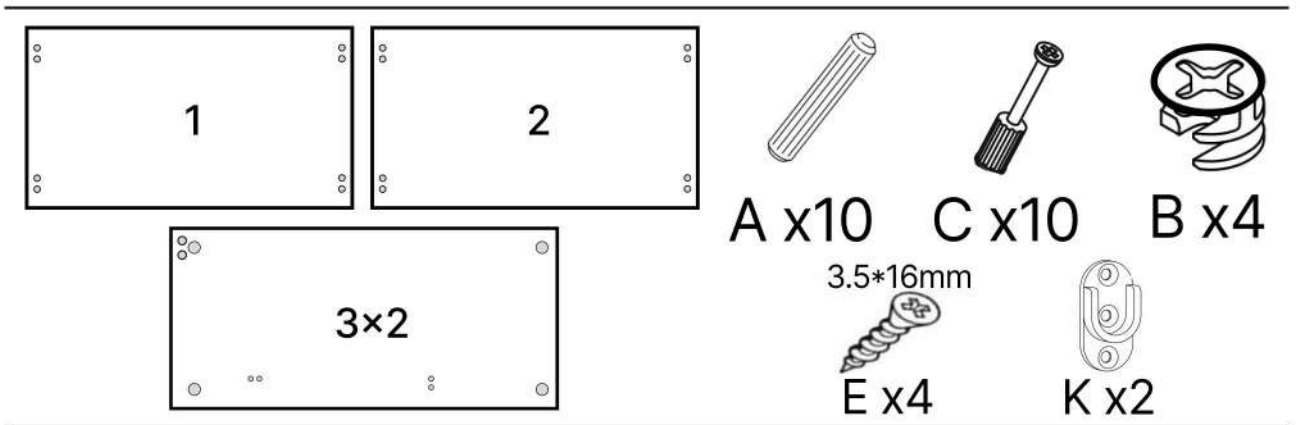



B x2

3

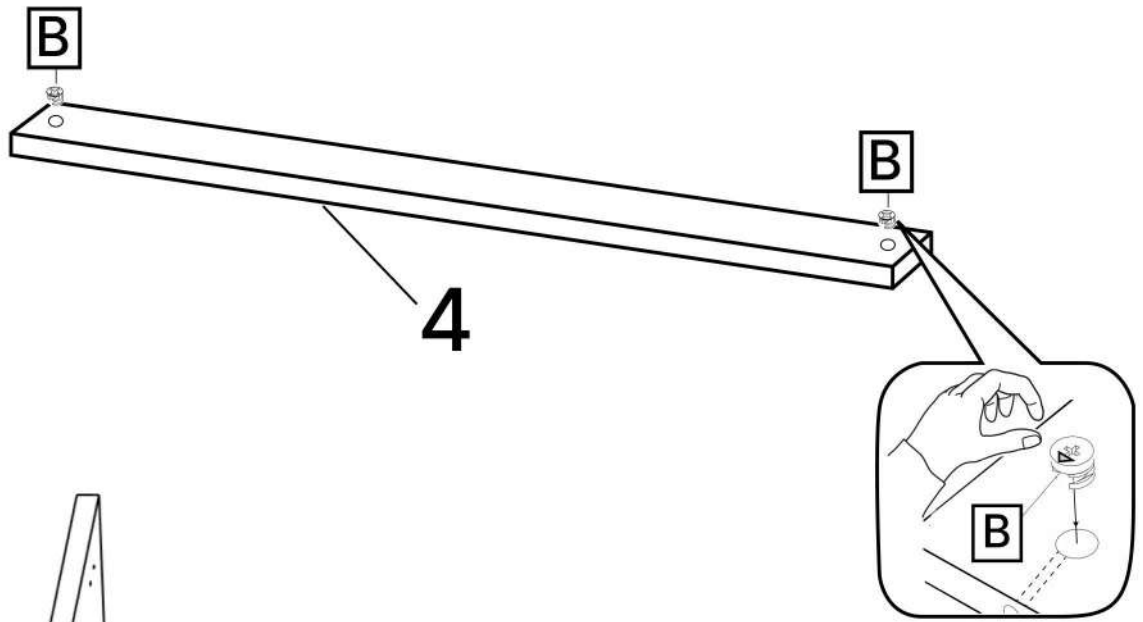

4

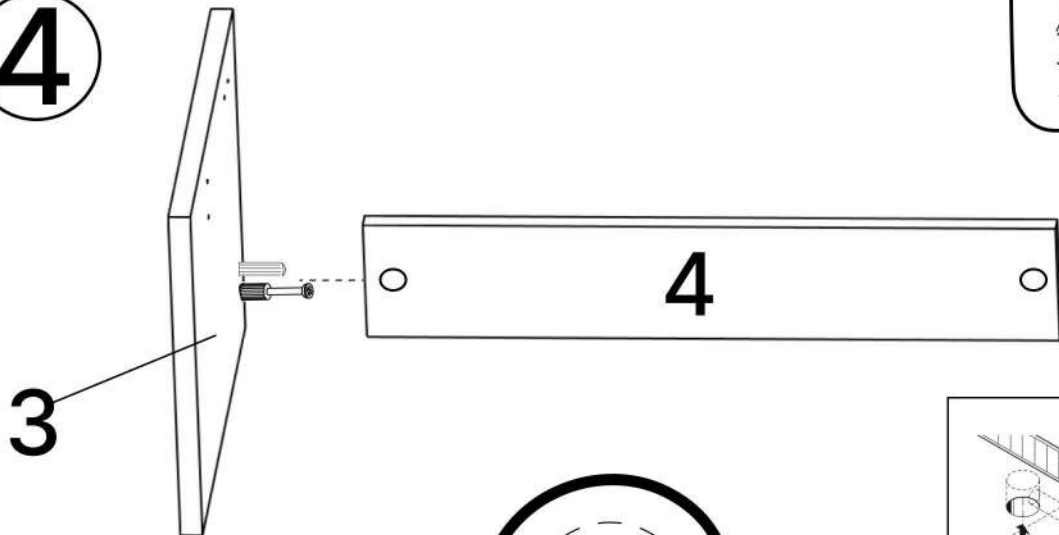

5

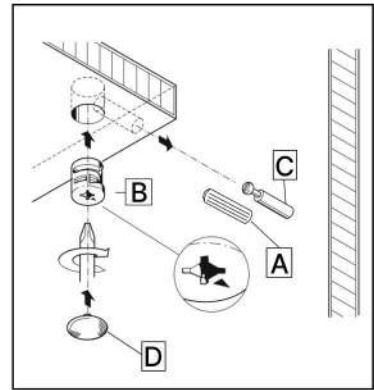
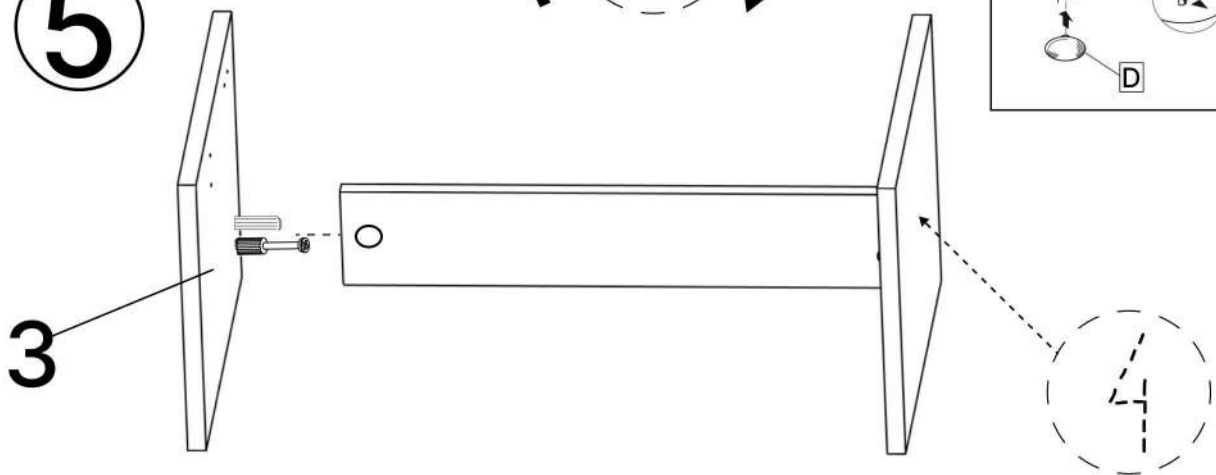

6

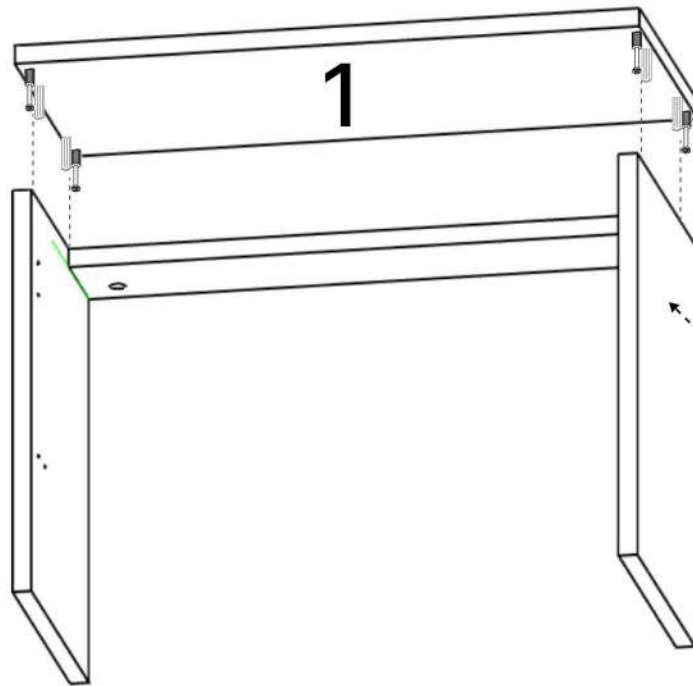

7

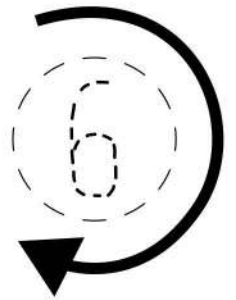
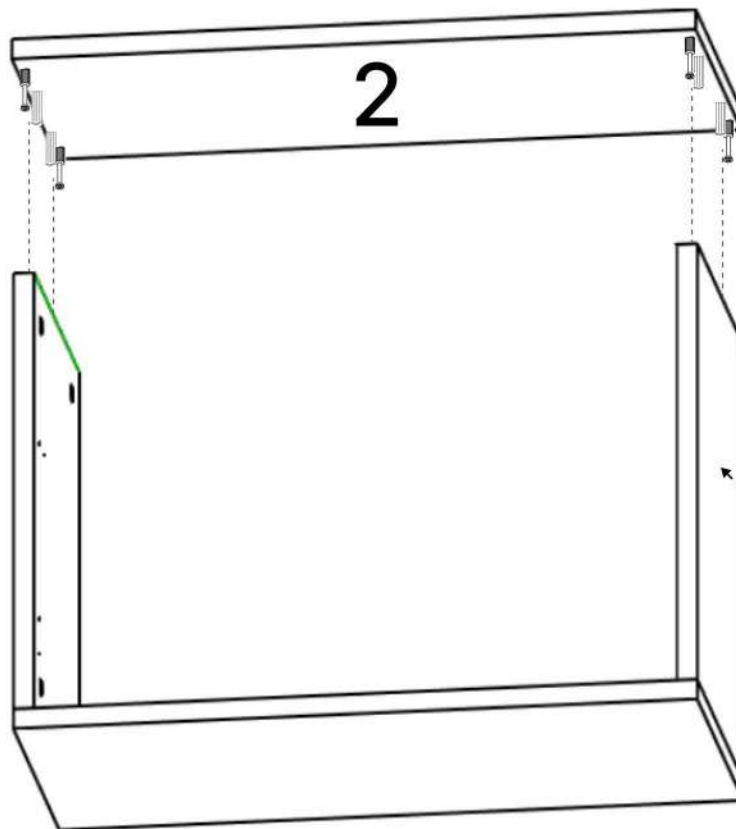

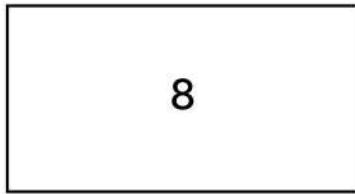

G x15gr. E x16 3.5\*16mm H x4

8

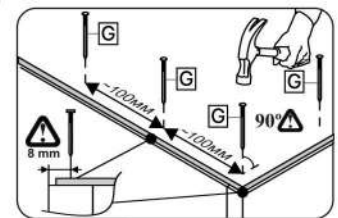
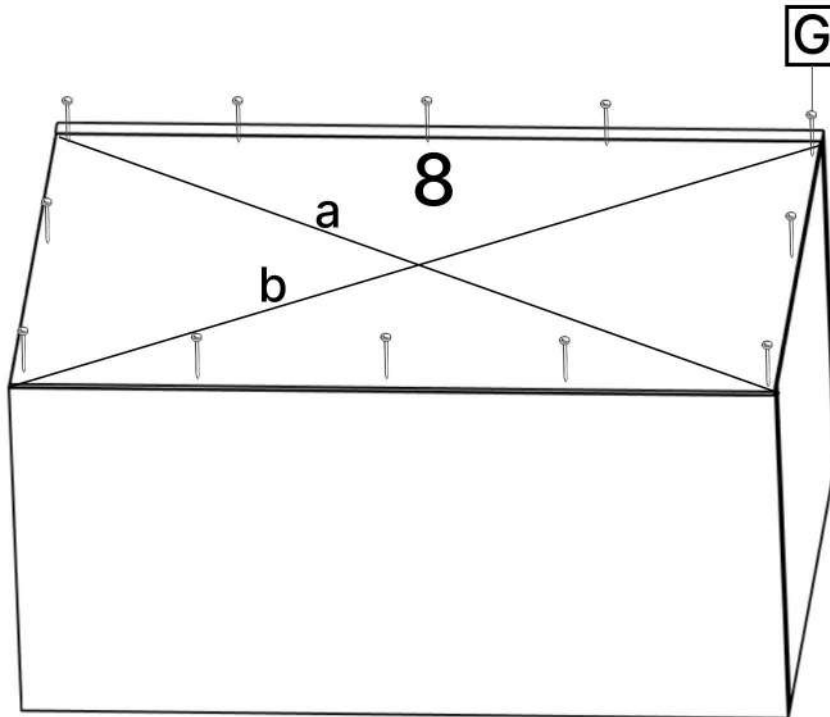

9

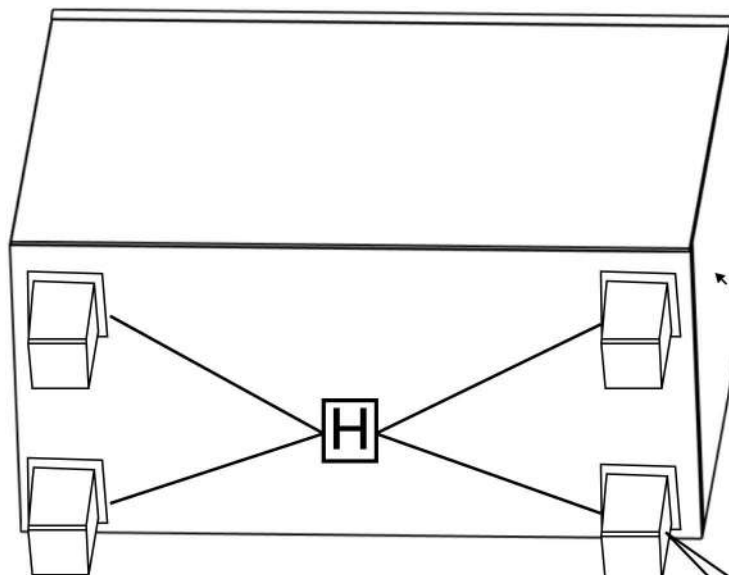

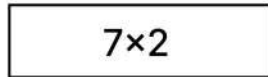
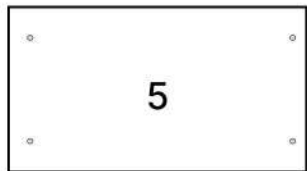

3.5\*16mm



E x12



F x1



L x1

10

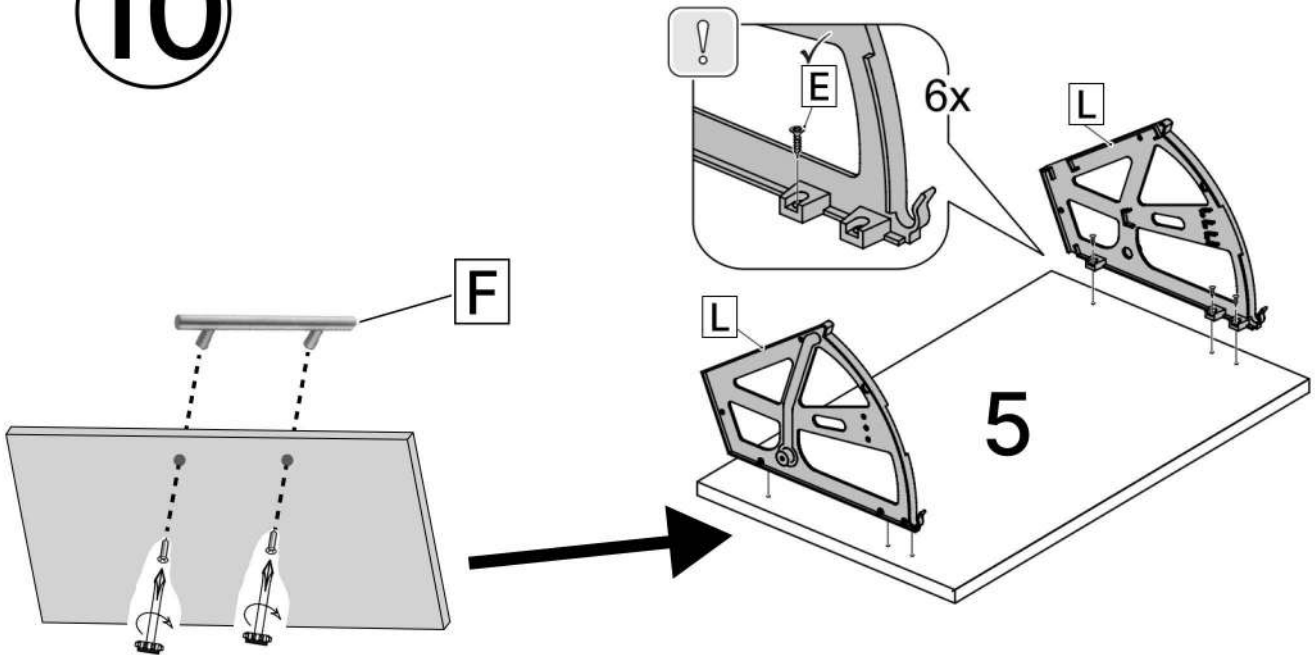

11

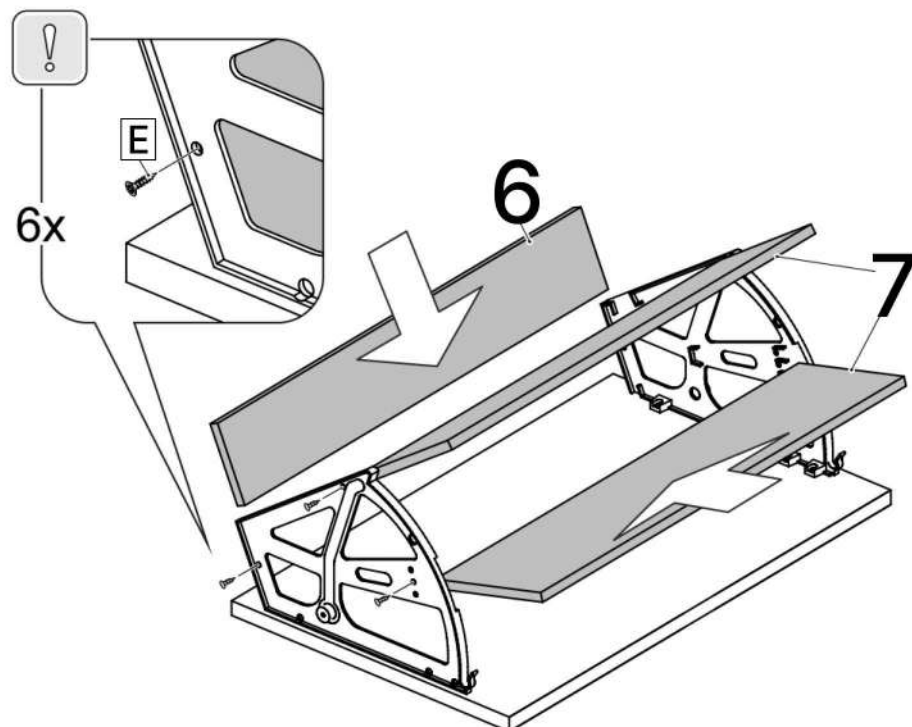



3.5\*16mm



E x4

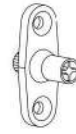

J x2

12

