

# Antreu "Siera"

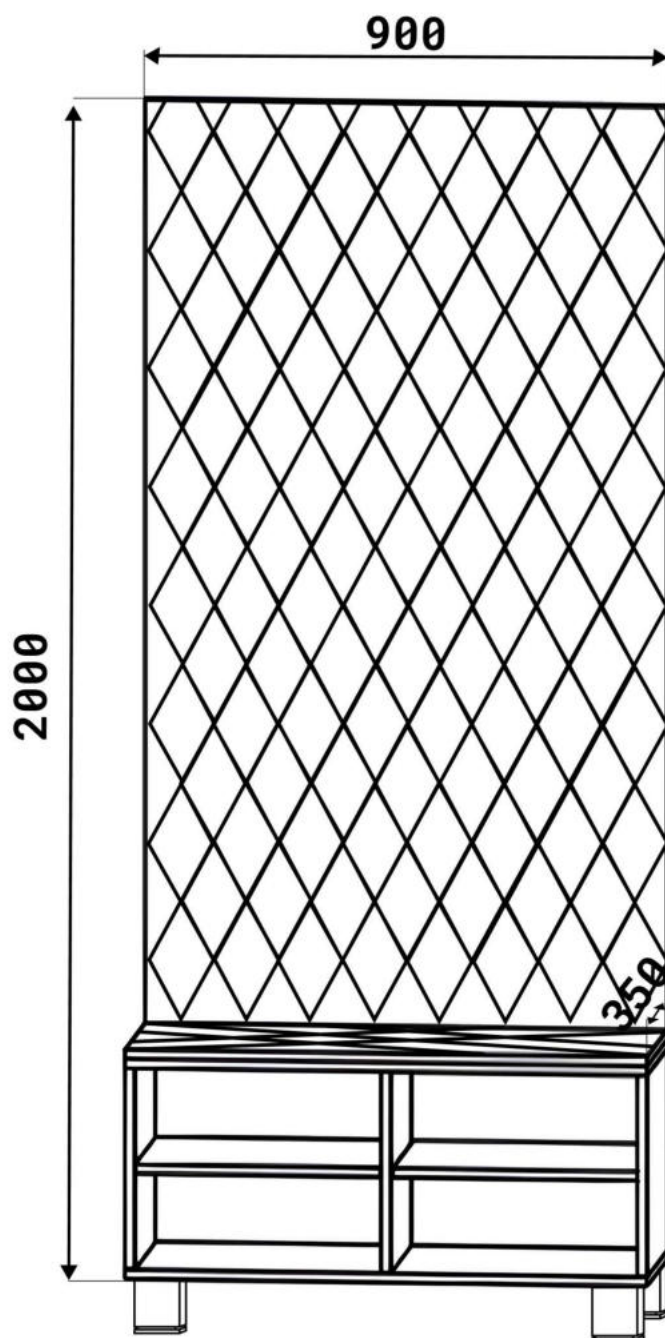

Adrese:  
Prospectul Republicii, 33  
Cahul, Moldova

str. Petricani 17/4  
Chisinau, Moldova

MD-3909

[serviceclient@fabrikhome.md](mailto:serviceclient@fabrikhome.md)  
[www.fabrikhome.md](http://www.fabrikhome.md)

Serviciu clienti:  
+373 299 32 277  
+373 799 07 807

Control calitate:  
+373 798 82 000



**Fabrik Home**

Mobila. Decor. Opinia.  
S.C. "Interstepcom" S.R.L.

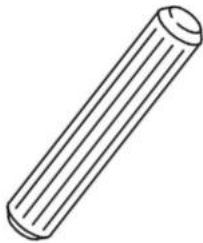
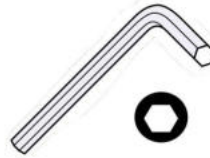
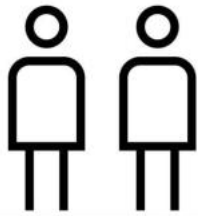

A x12



B x12



C x12

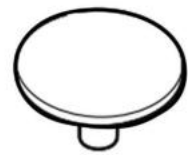

D x12



E x5

3.5\*20mm



F x38

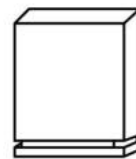

G x5

3.5\*30mm



H x10

6.3\*50mm



J x8

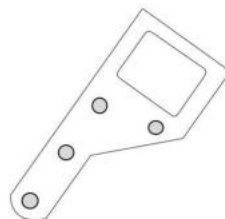

K x2



L x40gr.

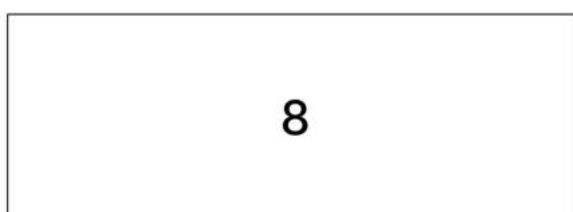
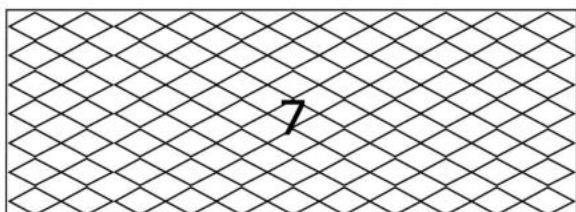
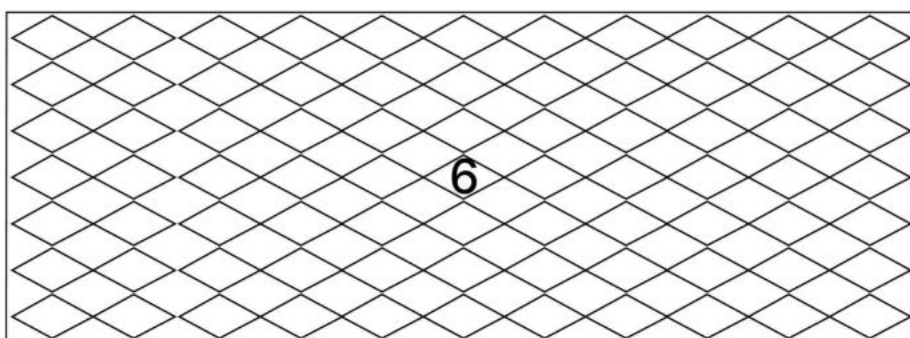
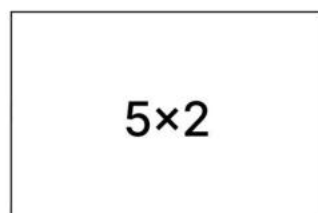
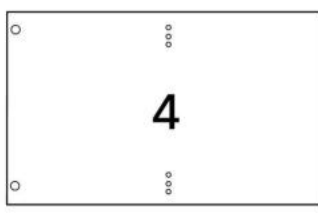
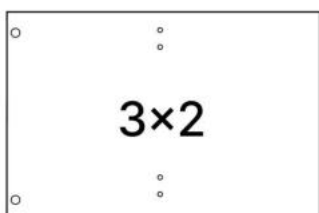
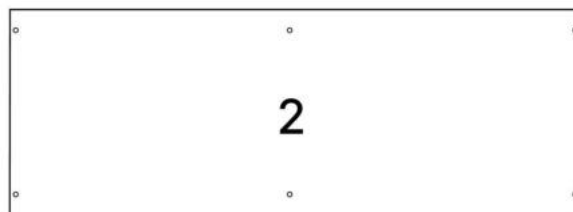
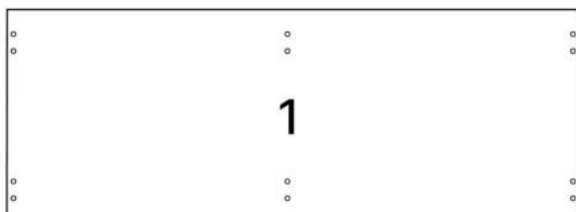

No	Denumire	Dimensiuni	Buc
1	Placă superioară	901x350	1
2	Placă inferioară	901x350	1
3	Placă leterala	344x350	2
4	Placă intermediara	344x348	1
5	Polita fixă	423x348	2
6	Placă moale mare	1602x900	1
7	Placă moale mică	901x350	1
8	Spate corp (PFL)	378x898	1

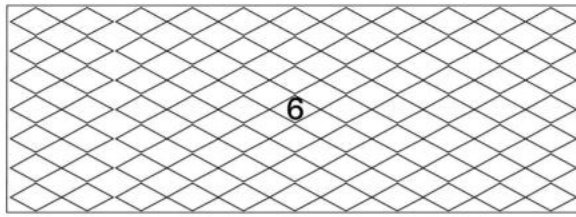

E x5



K x2

3.5\*20mm



F x18

1

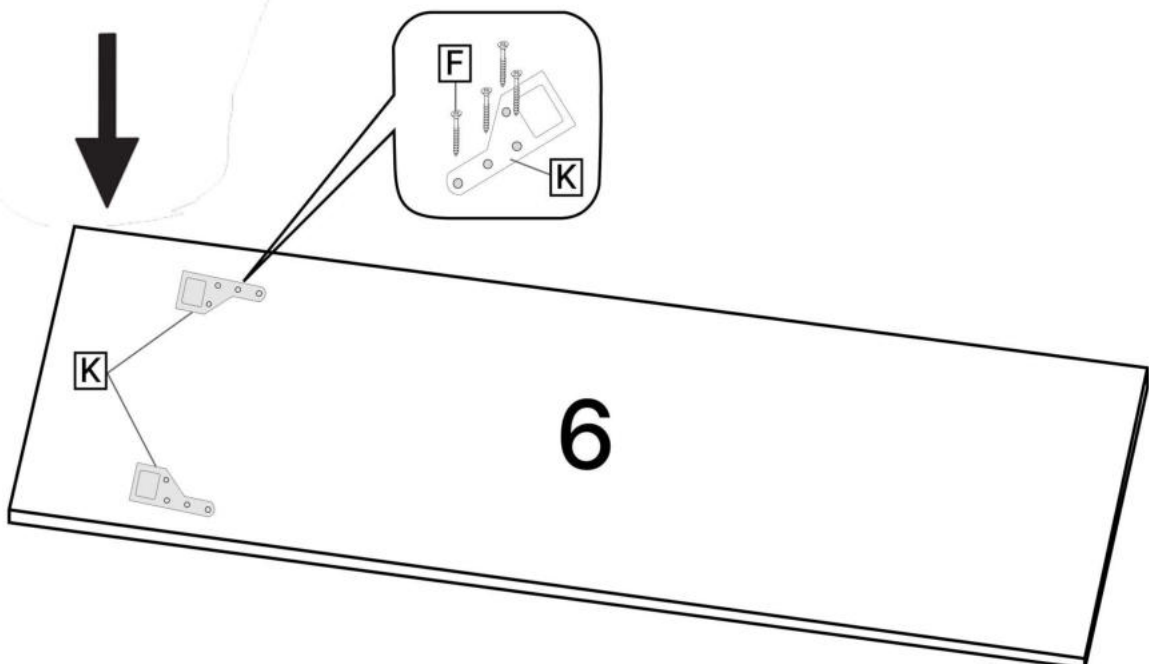
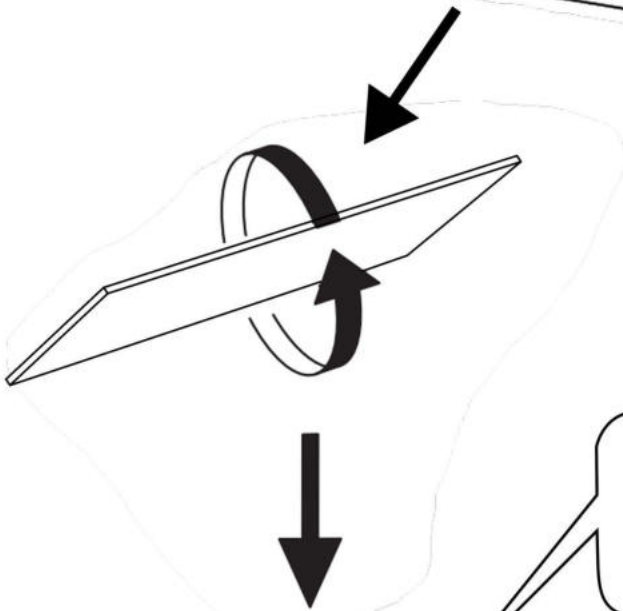
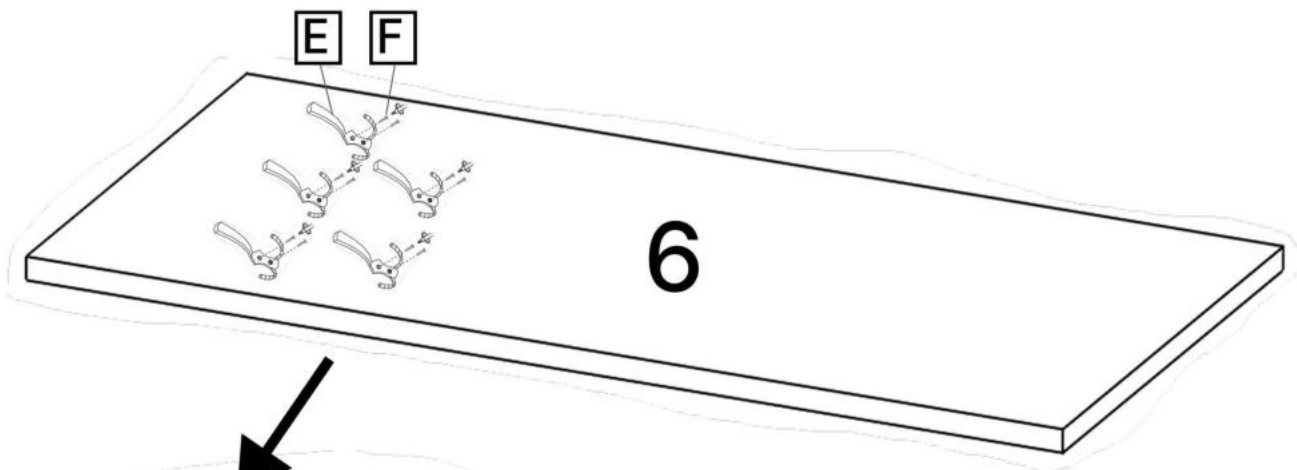



5x2



A x6



C x6



B x4

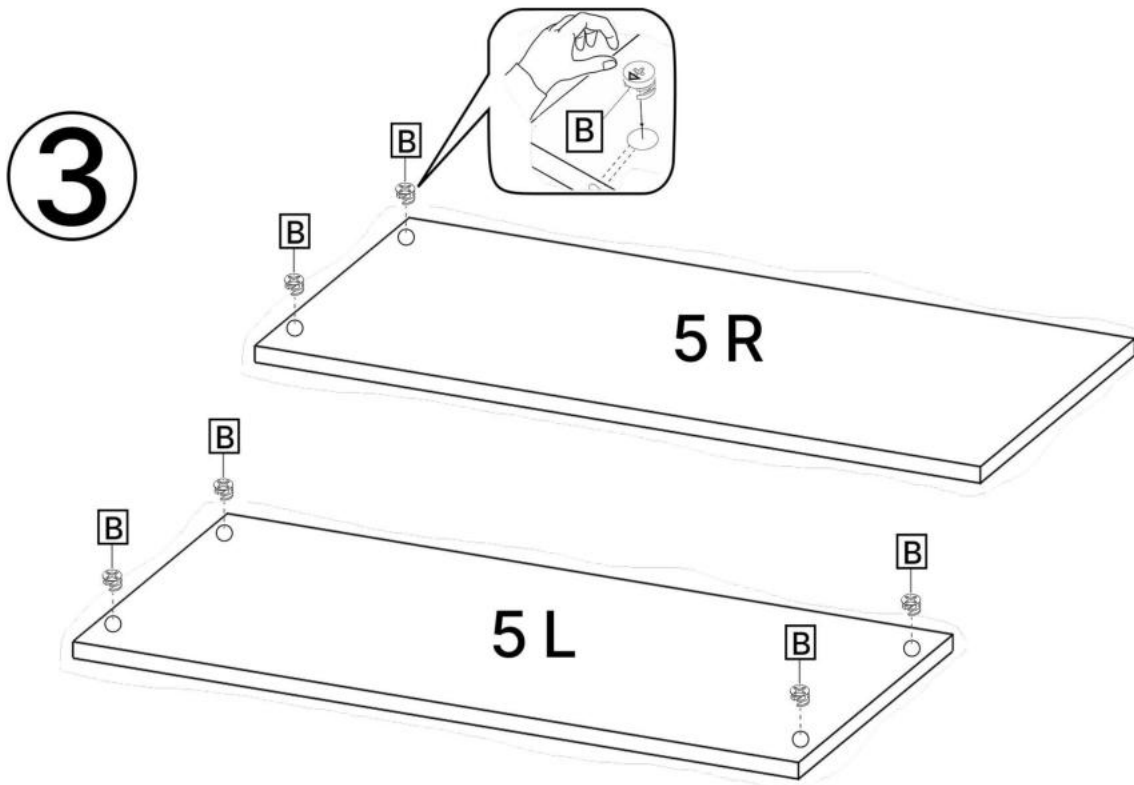
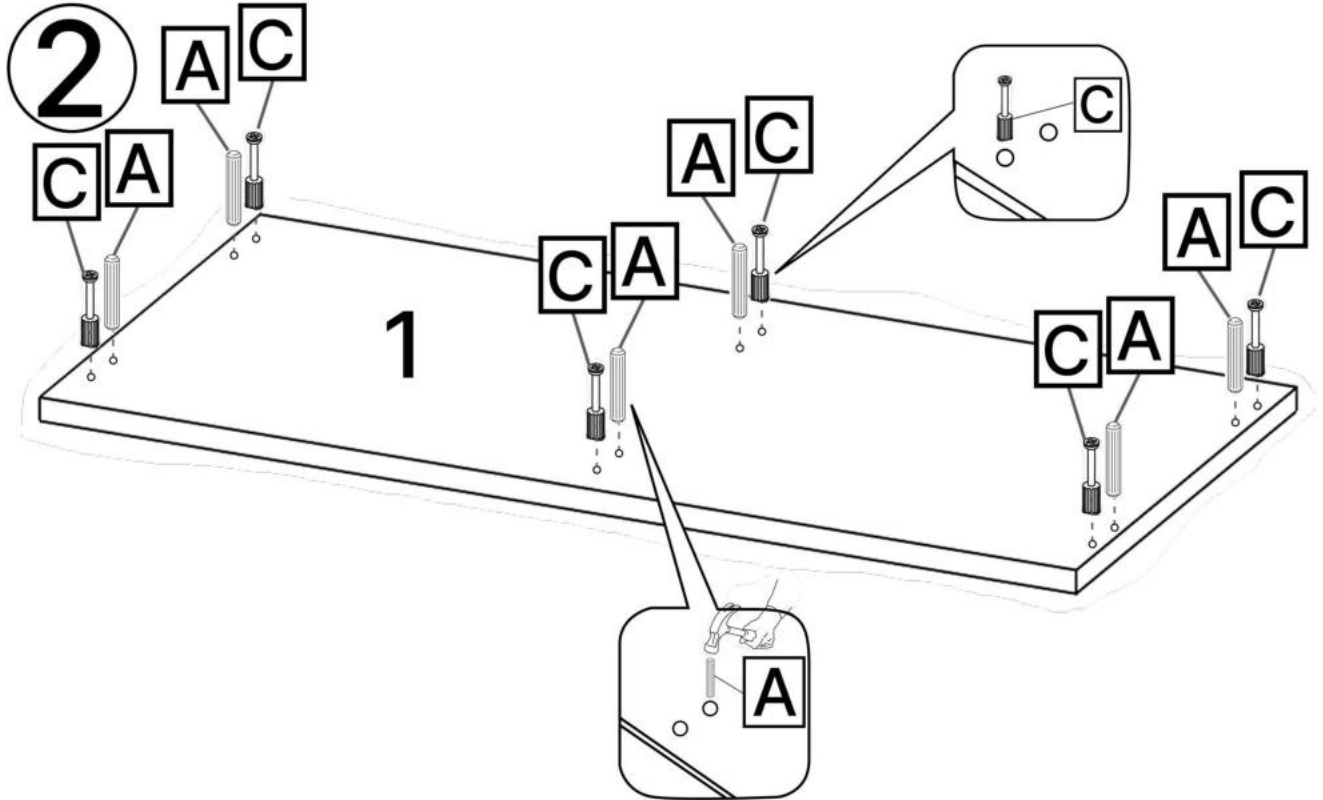

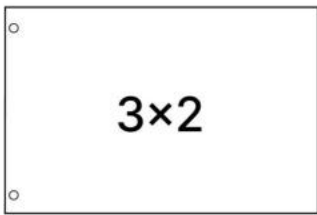

3x2

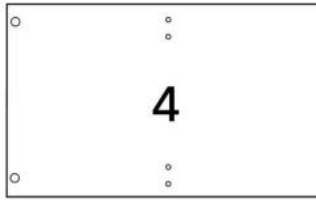

4



A x6



C x6



B x4

4

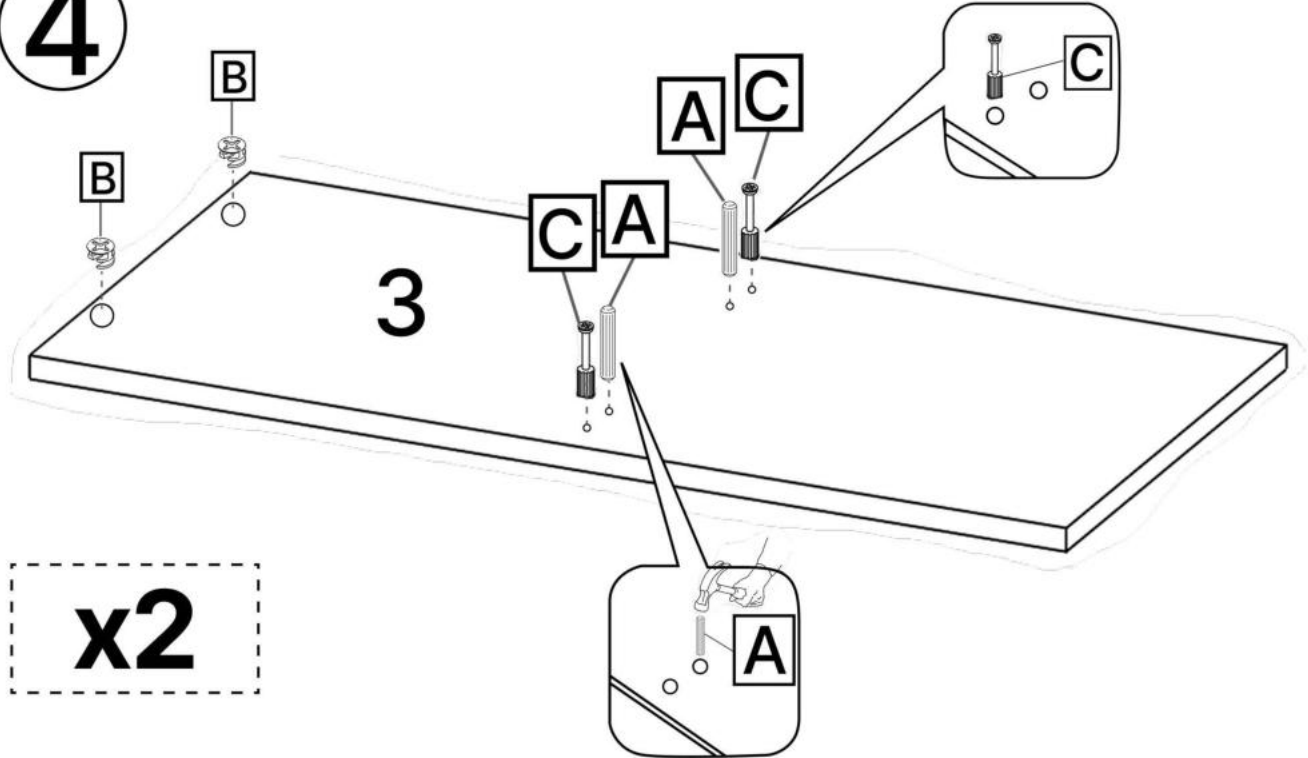

x2

5

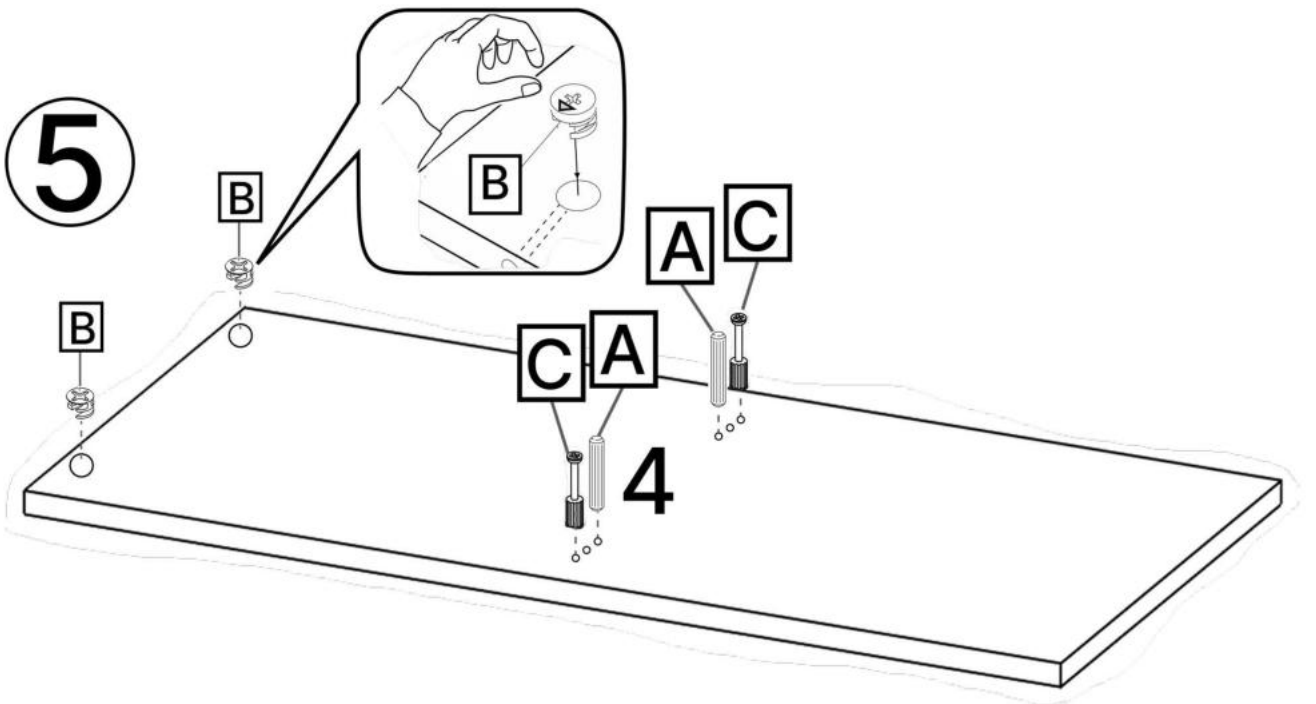

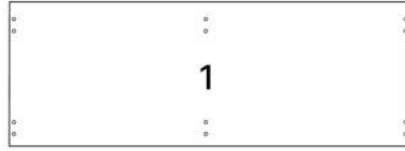
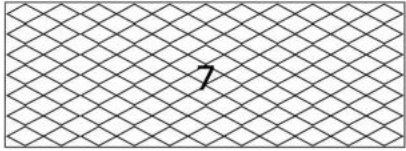

3.5\*30mm



H x10

6

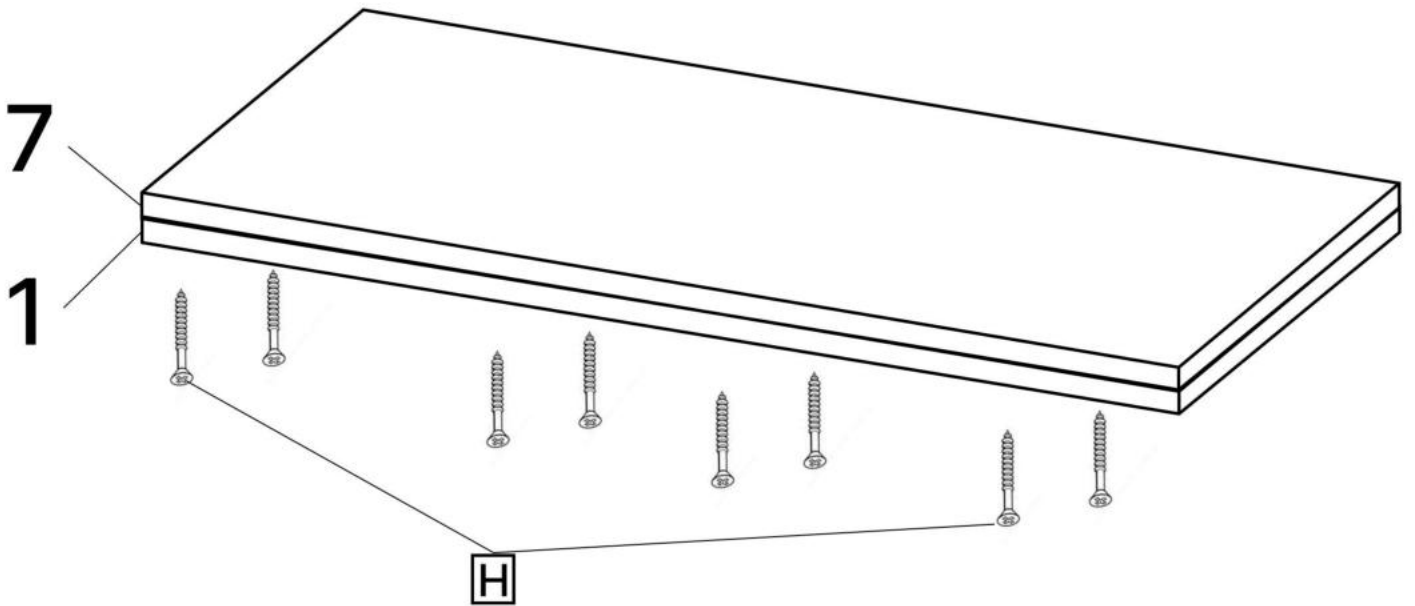

7

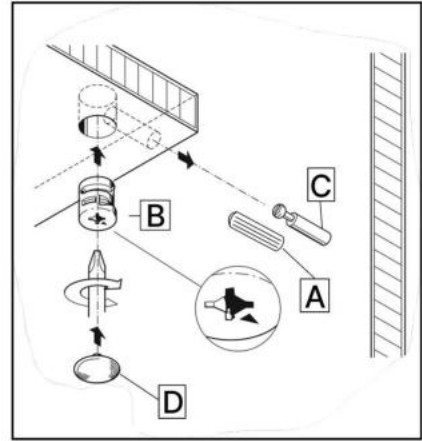
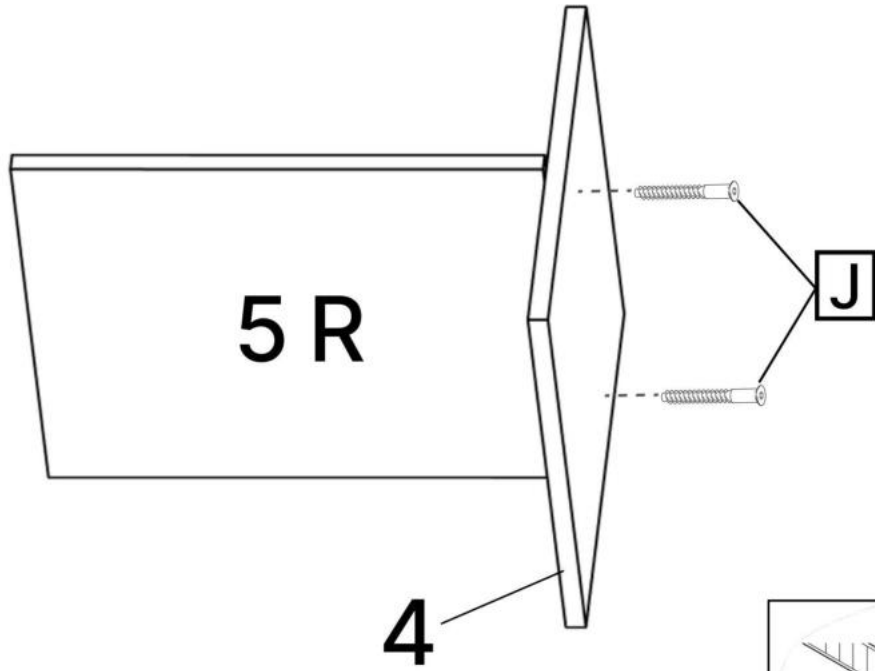

8

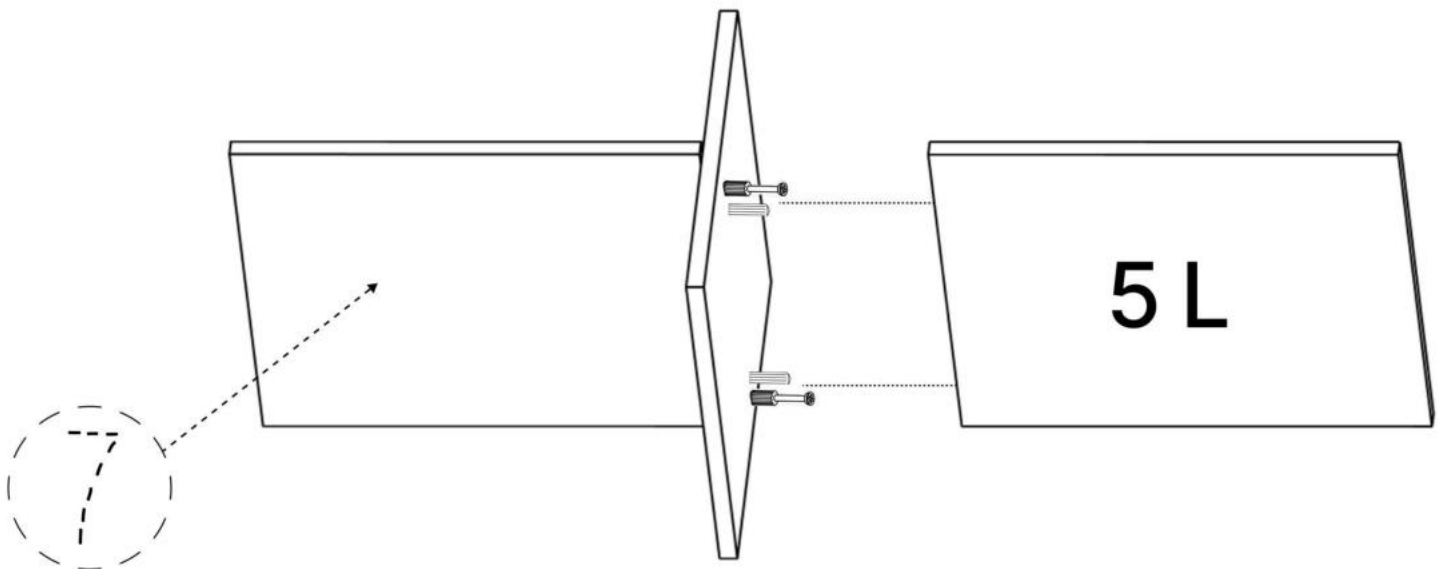

9

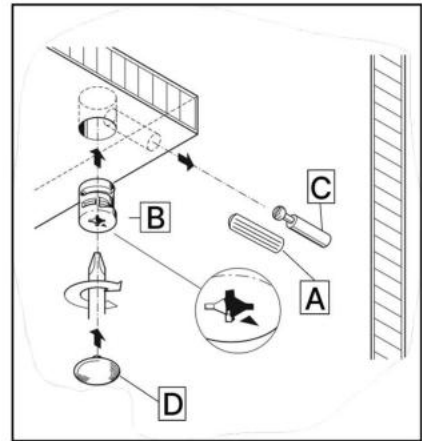
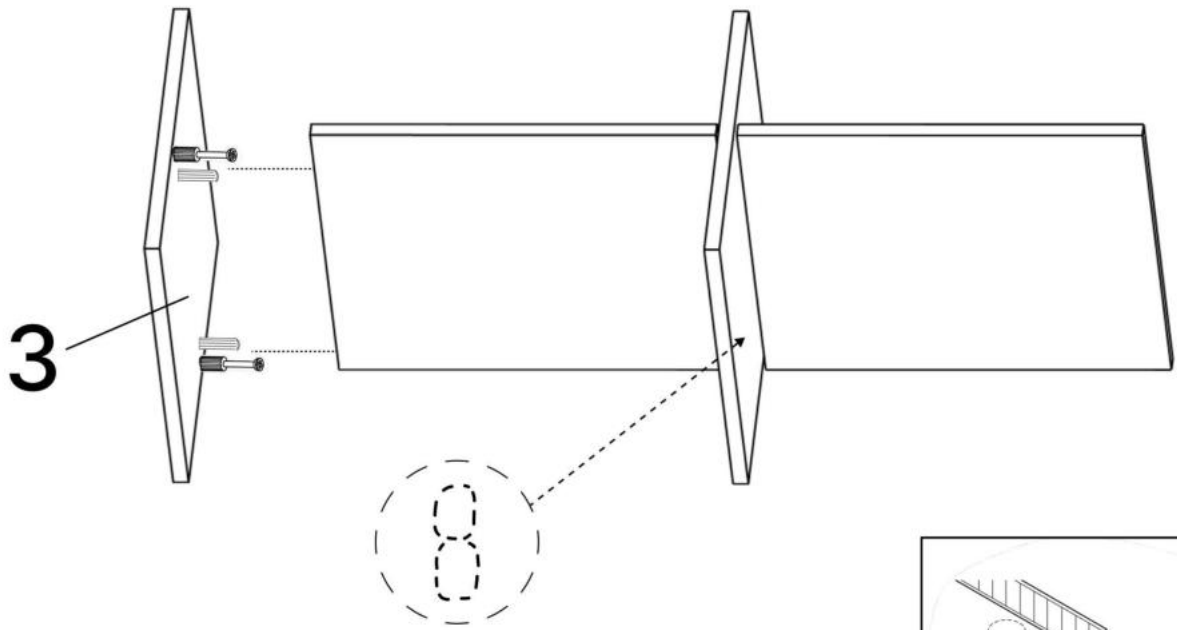

10

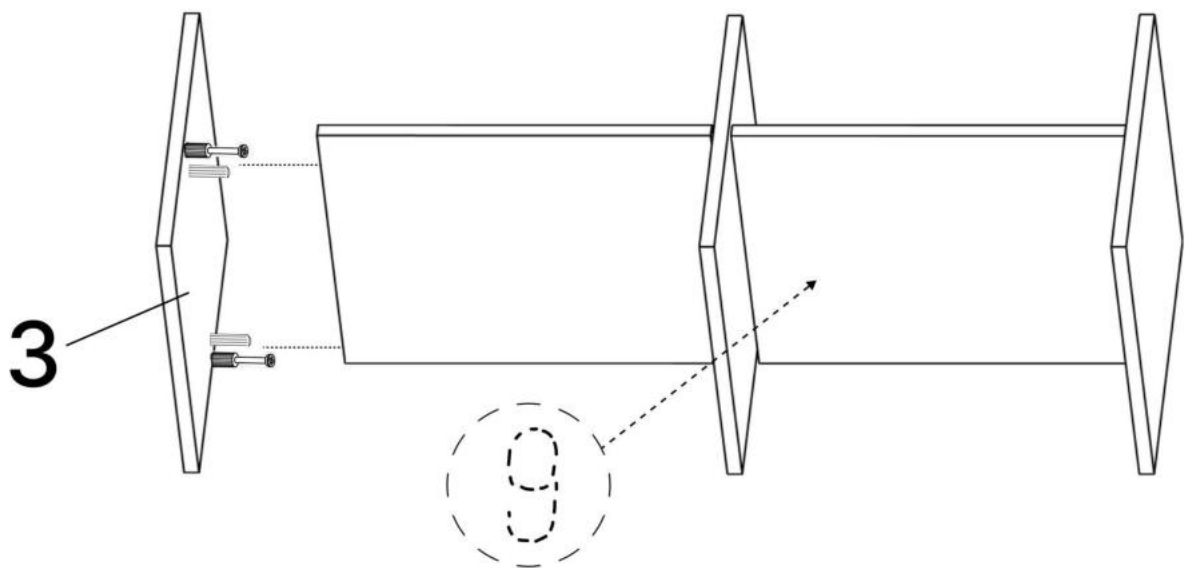

11

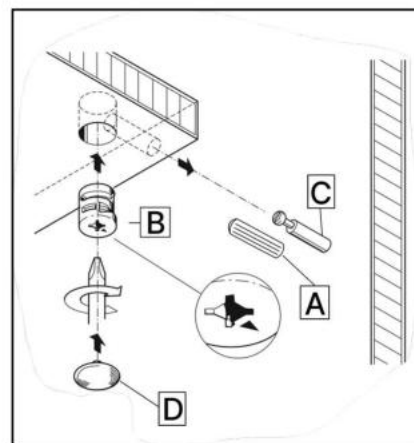
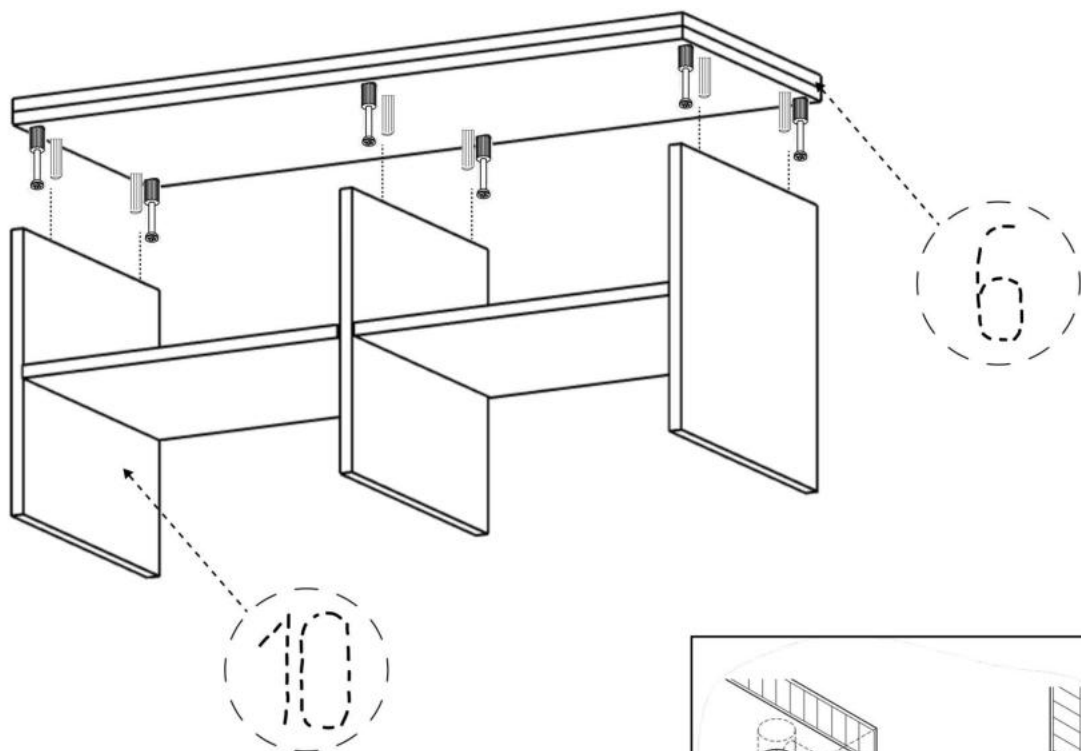

12

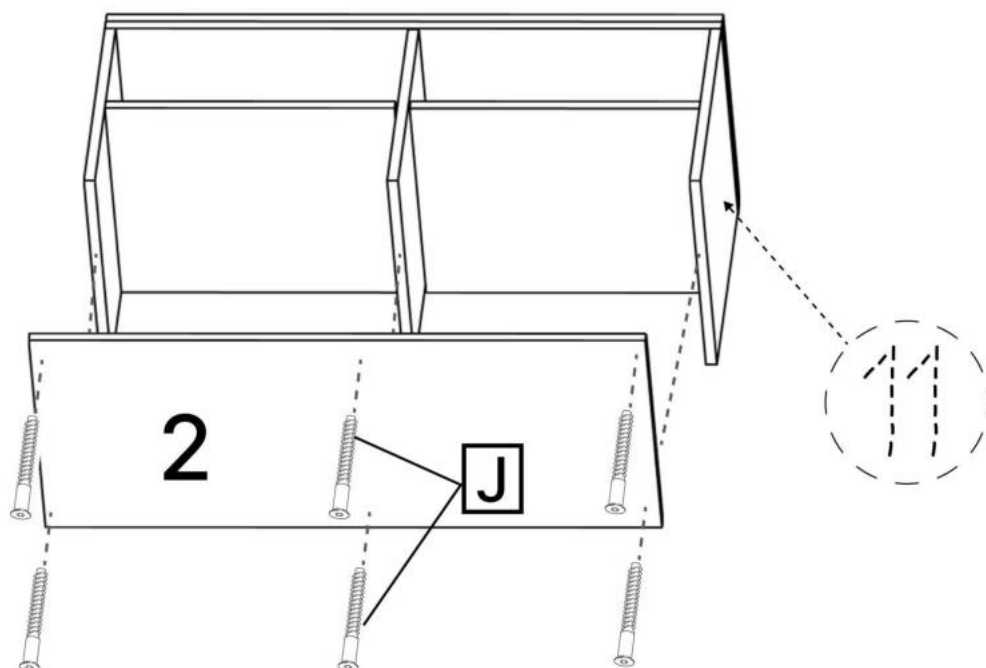

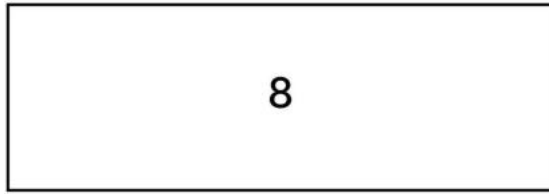

L x40gr.      3.5\*20mm      F x16      G x5

A drawing of a nail, a screw, and a small square panel.

**13**

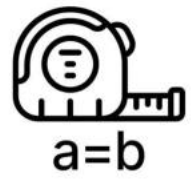
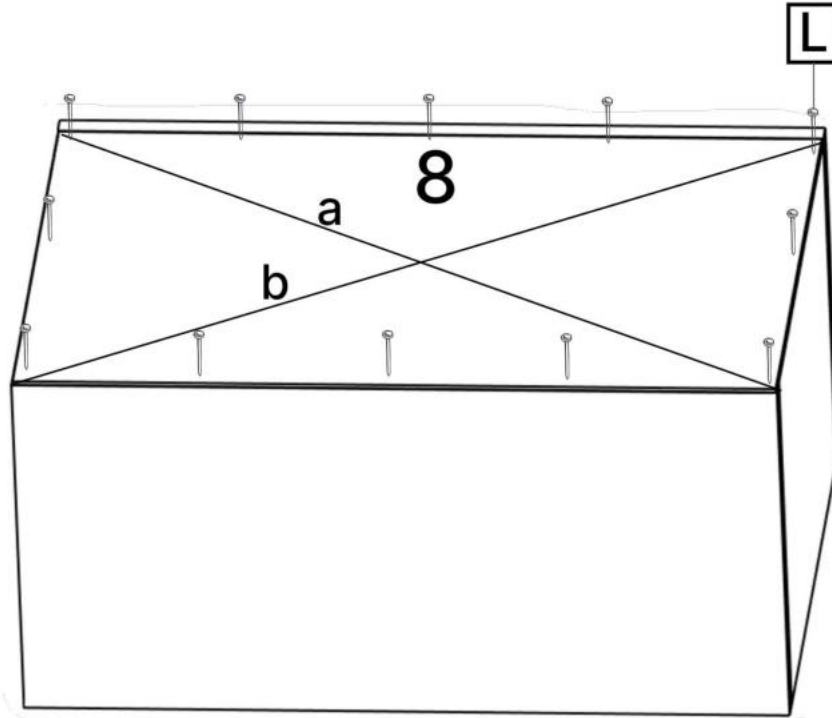

a=b

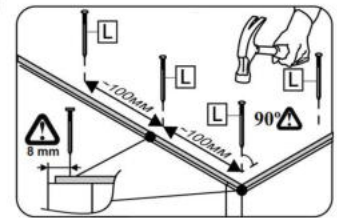

**14**

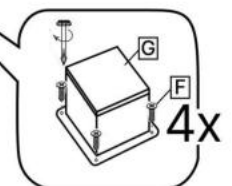
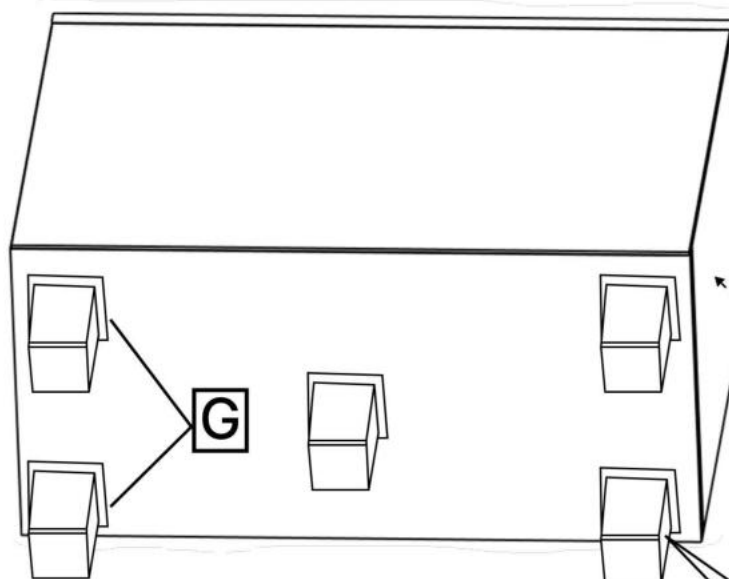

15

